

INSTALLATION, DRIFT OG VEDLIGEHOLD.

**KESSEL- *Linearis Compact***

*Model typer.*

Linearis Comfort 750 – 1150mm  
Linearis Compact 300 – 1150mm

Produkt nummer.



45600.63

- 100300064 Linearis Comfort - 750mm
- 100300065 Linearis Comfort - 850mm
- 100300066 Linearis Comfort - 950mm
- 100300067 Linearis Comfort - 1050mm
- 100300068 Linearis Comfort - 1150mm
- 100300069 Linearis Compact - 300mm
- 100300070 Linearis Compact - 450mm
- 100300071 Linearis Compact - 550mm
- 100300072 Linearis Compact - 650mm
- 100300073 Linearis Compact - 750mm
- 100300074 Linearis Compact - 850mm
- 100300075 Linearis Compact - 950mm
- 100300076 Linearis Compact - 1050mm
- 100300077 Linearis Compact - 1150mm

## INSTALLATION, DRIFT OG VEDLIGEHOLD.

1. Installation.	Installation. Rengøring. Montage mod væg. Montage på beton.	Side 3 Side 8 Side 9 Side 10
-----		
2. Generelt.	Generelt.	Side 12
-----		
3. Bemærkninger.	Note.	Side 13
-----		
4. Lydisolering.	Støjdæmpning.	Side 14
-----		

**Bemærk.** Linearis afløbsrende har en lav indbygningshøjde, og den indbyggede vandlås har derfor ikke en vandlukkehøjde på mindst 50 mm som krævet i Danmark. Det anbefales derfor, at Linearis afløbsrende tilsluttes på P-lås placeret under Linearis afløbsrenden i gulvkonstruktionen. For at sikre let tilgængelighed for rensning, bør afløbsrøret mellem Linearis afløbsrende og P-lås udføres med 2 stk. 45° bøjninger med et lige rørstykke mellem. Ved at udføre installationen som her beskrevet, vil eventuelle aflejringer i P-låsen let kunne fjernes med et rensbånd eller ved spuling med en havslange eller lignende.

Husk at følge bygningsreglementet m.h.t. vådrumssikring.

Linearis Compact

1. Installation.

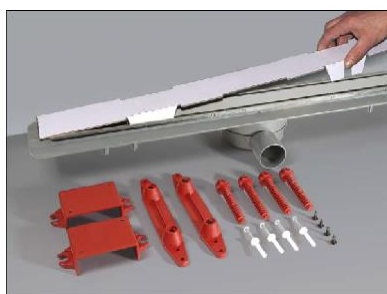
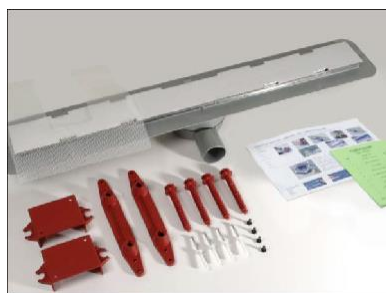

### Linearis Compact

#### 1. Installation.

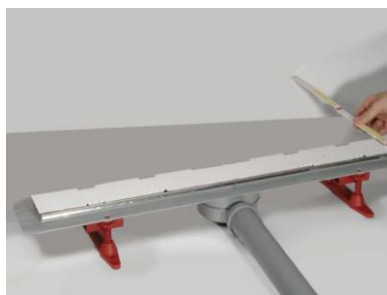
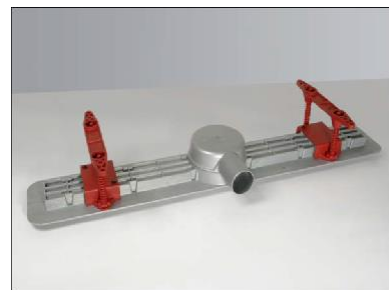

Linearis Compact

1. Installation.

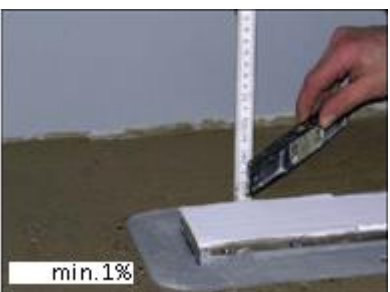
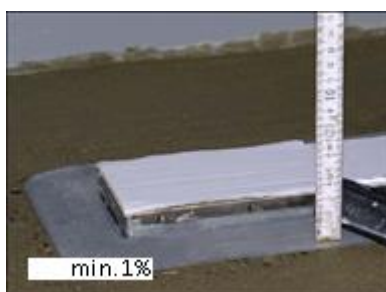

Linearis Compact

1. Installation.

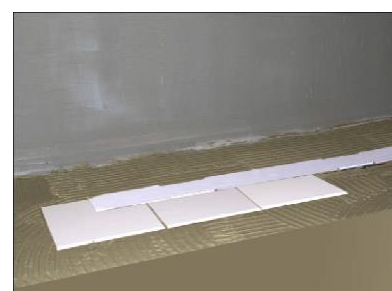

Linearis Compact

1. Installation.



Linearis Compact

## Rengøring.





Linearis Compact

Montage mod bagvæg.

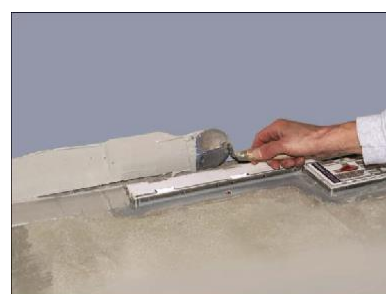
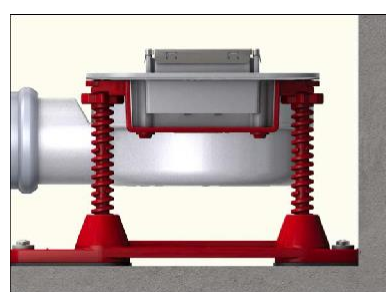

Linearis Compact

Montage på beton.



- a** Betongulv.
- b** Termisk og lydisolering.
- c** Radon folie.
- d** Pudslag.
- e** "måtte" til vådrumsmembran.
- f** Vådrumsmembran.
- g** Fliseklæb.
- h** Klinker.

Installationseksempel til laveste flisehøjde

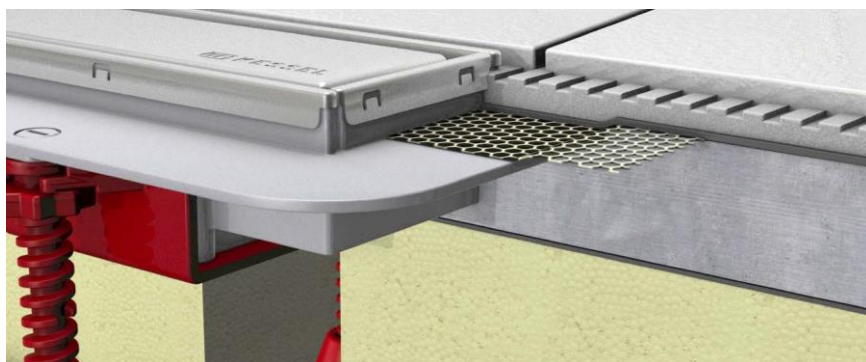

Linearis Compact

## Montage på beton.

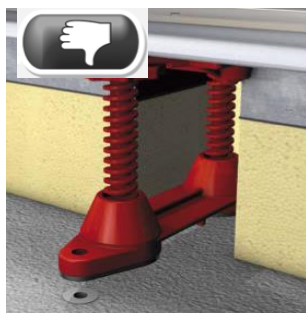
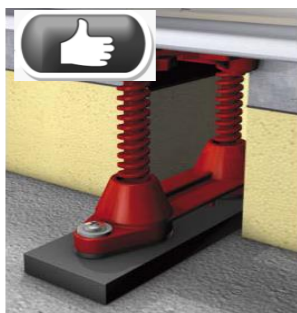

- a Betongulv.
- b Termisk og lydisolering.
- c Radonfolie.
- d Pudslag.
- e "måtte" til vådrumsmembran.
- f Vådrumsmembran.
- g Fliseklæb.
- h Klinker.

Linearis Compact

Brusevæg

Generelt.

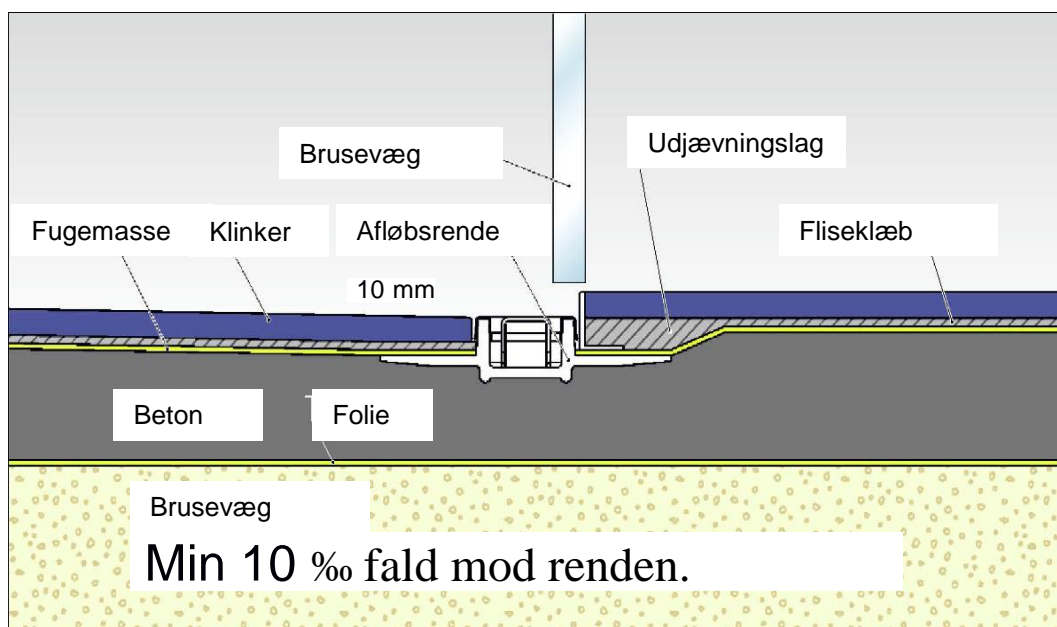
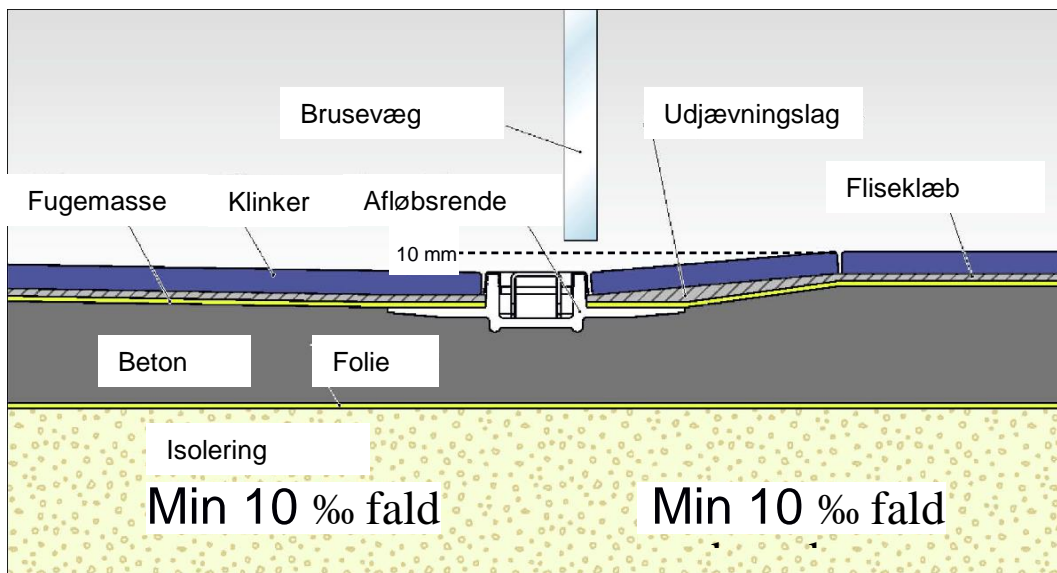

Linearis Compact

Note.

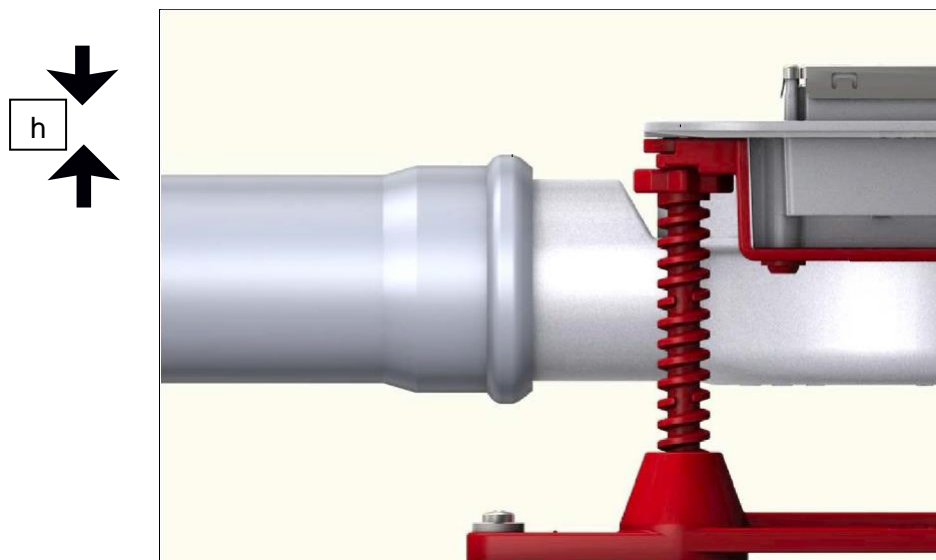

Grundet den lave rør dækning (h) anbefales det at anvende en egnet mineralsk fliseklæb. Dette er for at minimere risikoen for revnedannelser.

O.B.S. Der må ikke anvendes aggressive rengøringsmidler, f.eks. klorbaseret produkter. Dette vil kunne skade afløbsristen.

Ved betonrester på rist og rende fra montagen, fjernes dette med rent vand.

Linearis Compact

Lydisolering.

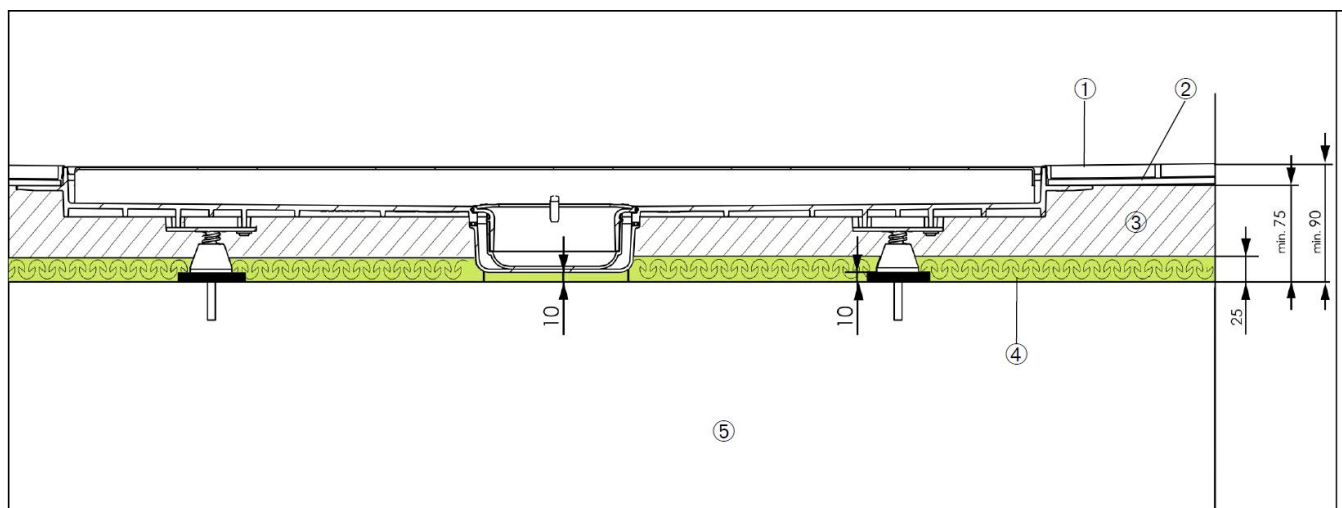

1. Fliser.
2. Fliseklæb.
3. Beton.
4. Lydisolering.
5. Betondæk.